

SAHIR

1 X1x

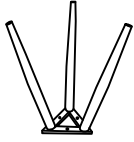

2 X1x



A X4x







B X4x

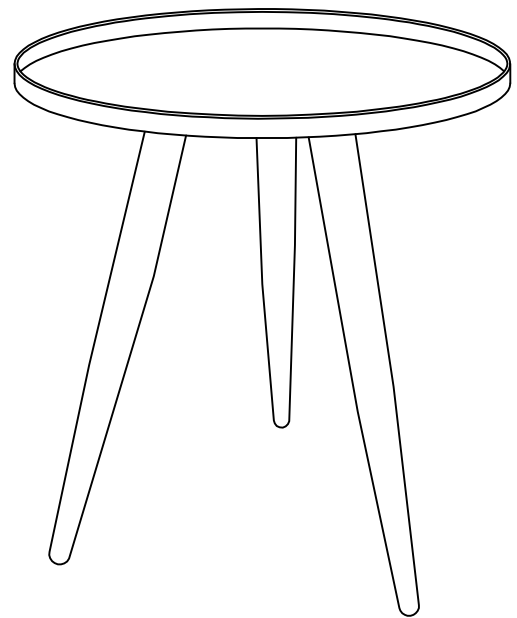
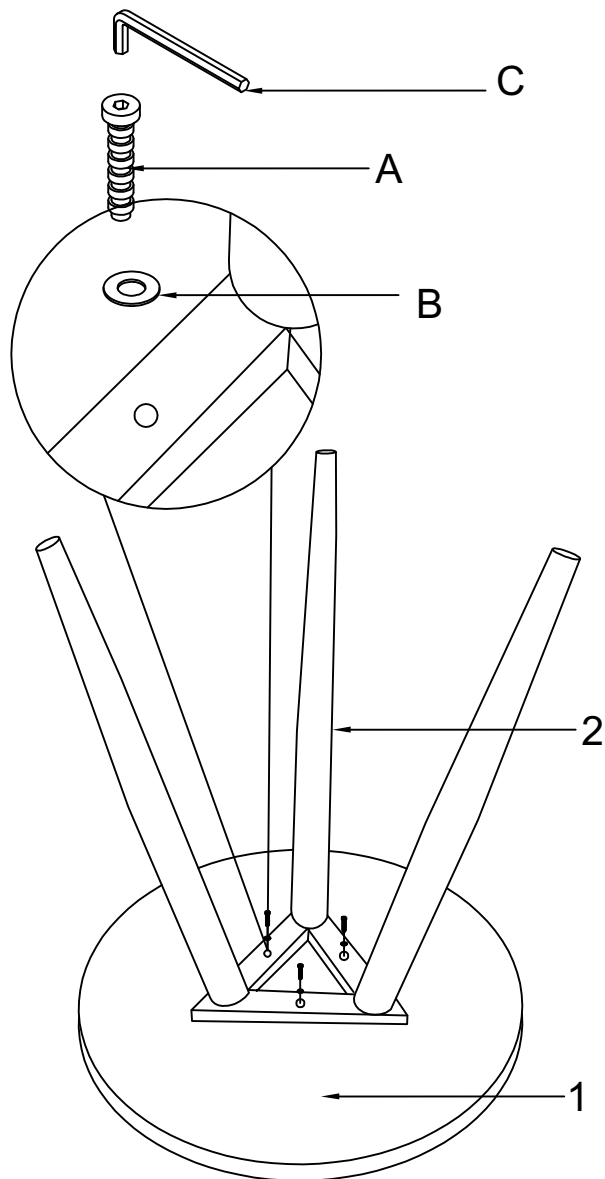

C X1x



A		1
B		2
C		4
D		1
E		4

